

# BALLARD DESIGNS®

## ROSWELL COLLECTION

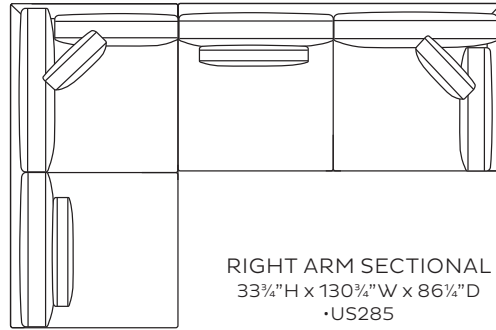

RIGHT ARM SECTIONAL  
33¾"H x 130¾"W x 86¼"D  
•US285

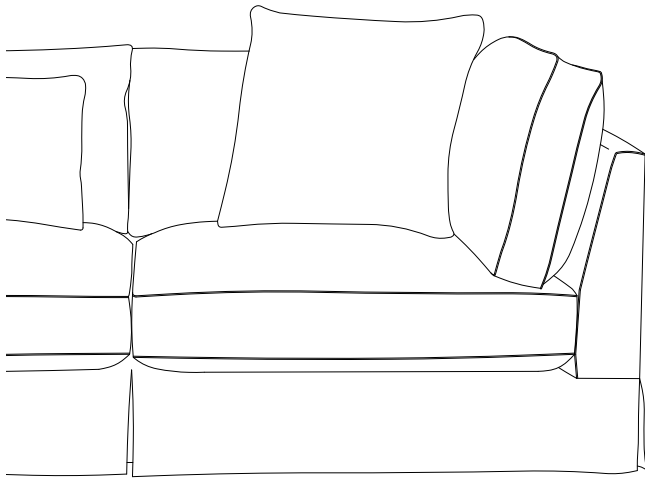
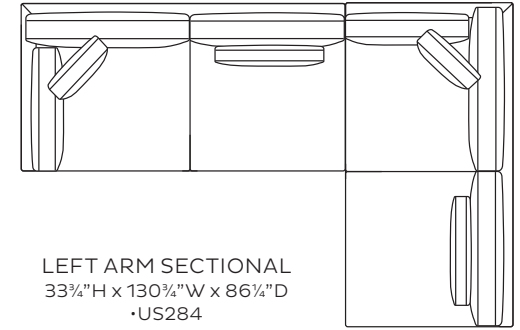

LEFT ARM SECTIONAL  
33¾"H x 130¾"W x 86¼"D  
•US284

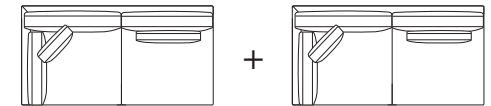
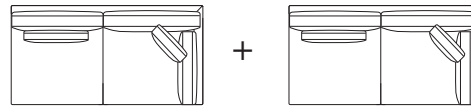

### TIP

*To create a 2-Piece Roswell sectional, you combine two Right Arm Sofas or Two Left Arm Sofas. Trust us, it works - and it's soooo comfy.*

More configurations on back.

## SECTIONAL COMPONENTS

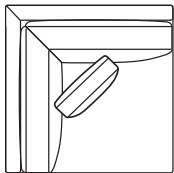

CORNER CHAIR  
33¾"H x 44½" Sq  
•US412

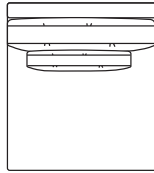

ARMLESS CHAIR  
33¾"H x 42"W x 42"D  
•US413

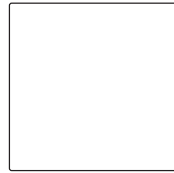

OTTOMAN  
19½"H x 44½"W x 44½"D  
•US283

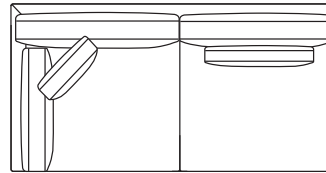

LEFT ARM SOFA  
33¾"H x 86¼"W x 44½"D  
•US281

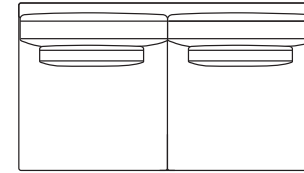

ARMLESS SOFA  
33¾"H x 79¾"W x 44½"D  
•US414

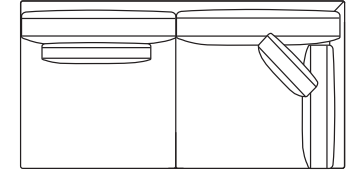

RIGHT ARM SOFA  
33¾"H x 86¼"W x 44½"D  
•US282

# BALLARD DESIGNS®

## ROSWELL COLLECTION

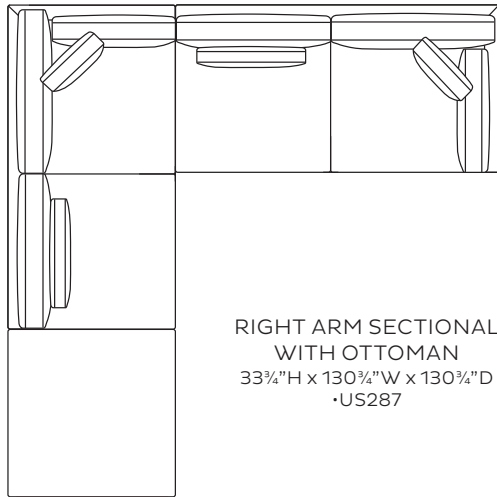

RIGHT ARM SECTIONAL  
WITH OTTOMAN  
33¾"H x 130¾"W x 130¾"D  
•US287

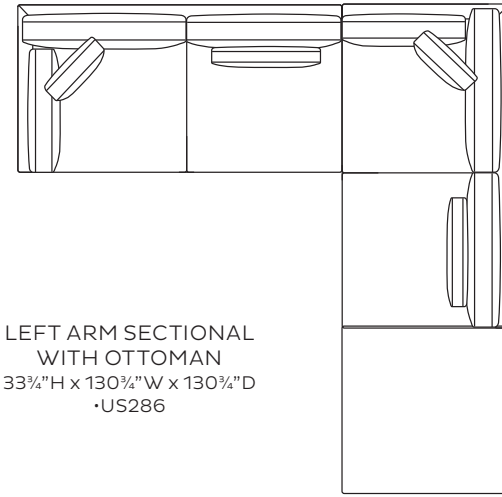
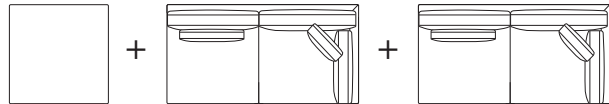

LEFT ARM SECTIONAL  
WITH OTTOMAN  
33¾"H x 130¾"W x 130¾"D  
•US286

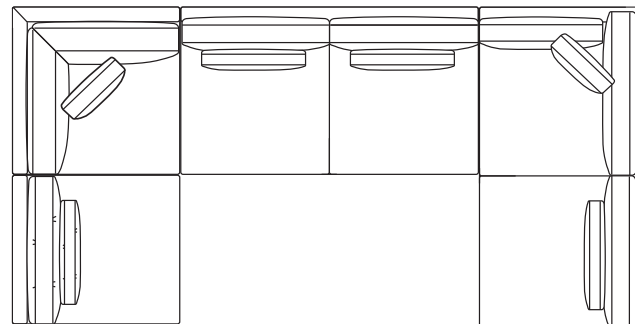
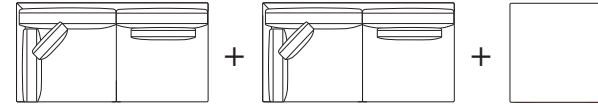

5 PIECE SECTIONAL  
33¾"H x 168¾"W x 86½"D  
•US435

